

FITTING INSTRUCTION

Clamp mark in acc. with		Cables joining
ISO	PN	
1	L	Left directional lights
2	+	Rear fog lights
3	31	Ground
4	R	Right directional lights
5	58R	Right side parking lights
6	54	Stoplights
7	58L	Left side parking lights

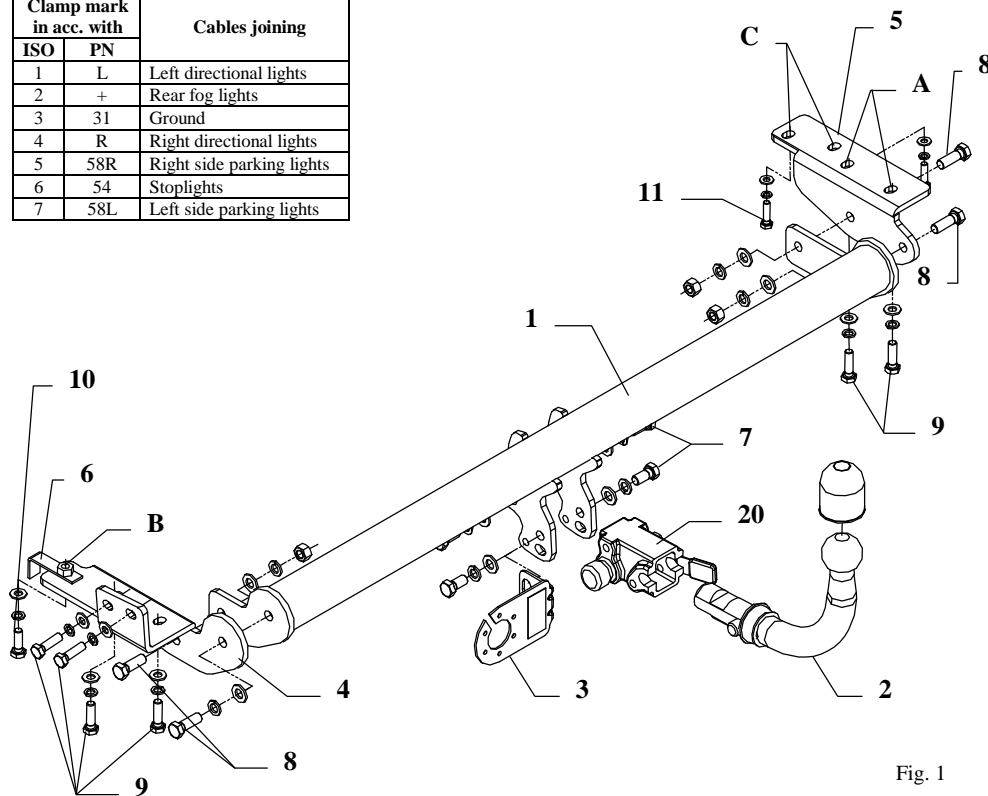

Fig. 1

This towbar is designed to assembly in following cars:
NISSAN PRIMERA P10, 4-5 doors, produced since 06.1990 till 09.1996,
 catalogue no. **V12A** and is prepared to tow trailers max total weight
1700 kg and max vertical load **75 kg**.

From manufacturer

Thank you for buying our product. Their reliability has been confirmed in many tests. Reliability of towbar depends also on correct assembly and right operation. For this reasons we kindly ask to read carefully this instruction and apply to hints.

The towbar should be install in points described by a car producer.

The instruction of the assembly

1. Disassemble the bumper, rear muffler handle and original towing eye (not used any more).
2. To right chassis member fix bracket (pos. 5) using bolts M10x1,25x35mm (pos. 9) through holes (pos. A - loosely).
3. To left chassis member fix bracket (pos. 4) using bolts M10x1,25x35mm (pos. 9) through four holes (loosely), and through hole (pos. B) bolt M10x30mm (pos. 10). Use handle with nut M10 (pos. 6).
4. Between brackets (pos. 4 and 5) slip main bar of the towbar (pos. 1) and fix using bolts M12x35mm (pos. 8).
5. Tighten all bolts according to the torque shown in the table.
6. Assemble:
 - rear muffler handle to element (pos. 5) through holes (pos. C).
 - bumper, after his cut (see fig. 2.)
7. Fix body of the automat (pos. 20) and the socket plate (pos. 3) using bolts M12x25mm (pos. 7) from accessories. Place tow-ball (pos. 2) according to supplied instruction.

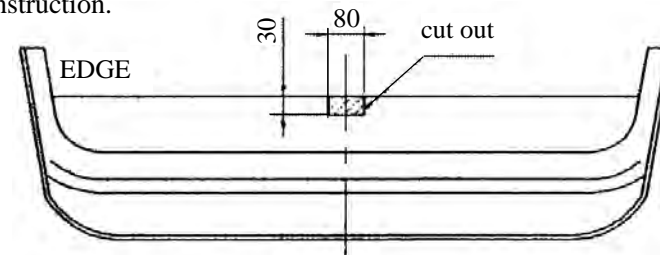

Fig. 2

8. Connect electric wires of 7-poles socket according to the instruction of the car. (Recommend to make at authorized service station)
9. Complete the paint coating damaged during installation.

Torque settings for nuts and bolts (8,8):	
M 8 - 25 Nm	M 10 - 55 Nm
M 12 - 85 Nm	M 14 - 135 Nm





NOTE

After install the towbar you should get adequate note in registration book (at authorised service station).The car should be equipped with:

- Indicators
- Tow mirrors

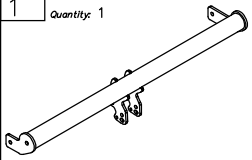
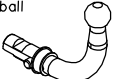
After 1000km check all bolts and nuts. The ball of towbar must be always kept clear and conserve with a grease.

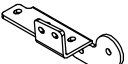
Towbar accessories:

Pos. 1 Name: Main bar Quantity: 1	Pos. 5 Name: Right bracket Quantity: 1	Pos. 10 Name: Bolt 8,8 B Quantity: 1 Dim.: M10x30mm	Pos. 16 Name: Spring washer Quantity: 8 Dim.: ϕ 12,2 mm
	Pos. 6 Name: Handle with the nut Quantity: 1	Pos. 11 Name: Bolt 8,8 B Quantity: 2 Dim.: M8x30mm	Pos. 17 Name: Spring washer Quantity: 7 Dim.: ϕ 10,2 mm
Pos. 2 Name: Tow ball Quantity: 1	Pos. 7 Name: Bolt 8,8 B Quantity: 4 Dim.: M12x25mm	Pos. 12 Name: Nut 8 B Quantity: 3 Dim.: M12	Pos. 18 Name: Spring washer Quantity: 2 Dim.: ϕ 8,2 mm
	Pos. 8 Name: Bolt 8,8 B Quantity: 4 Dim.: M12x35mm	Pos. 13 Name: Washer Quantity: 2 Dim.: ϕ 25x ϕ 9x3mm	Pos. 19 Name: Ball cover Quantity: 1
Pos. 3 Name: Socket plate Quantity: 1	Pos. 9 Name: Bolt 8,8 B Quantity: 6 Dim.: M10x1.25x35mm	Pos. 14 Name: Plain washer Quantity: 8 Dim.: ϕ 13 mm	Pos. 20 Name: Body of the automat Quantity: 1
	Pos. 4 Name: Left bracket Quantity: 1	Pos. 15 Name: Plain washer Quantity: 7 Dim.: ϕ 10,5 mm	Pos. 21 Name: Body plug Quantity: 1
			



PPUH AUTO-HAK S.J.

Produkcja Haków Holowniczych
Henryk & Zbigniew Nejman
76-200 SŁUPSK ul. Słoneczna 16K
tel/fax (059) 8-414-414; 8-414-413
E-mail: office@autohak.com.pl
www.autohak.com.pl

Towing hitch (without electrical set)

Class: **A50-X** Cat. no. **V12A**

Designed for:

Manufacturer: **NISSAN**

Model: **PRIMERA**

Type: **P10, 4-5 doors**

produced since 06.1990 till 09.1996

Technical data:

D-value: 8,46 kN

maximum trailer weight: **1700 kg**

maximum vertical cup load: **75 kg**

Approval number according to Directive 94/20/EC: **e20*94/20*1067*00**

Foreword

This towbar is designed according to rules of safety traffic regulations. The towing hitch is a safety component and can be install only by qualified personnel. Any alteration or conversion of the towing hitch is prohibited and would lead to cancellation of design certification. Remove insulating compound and underseal from vehicle (if present) in the area of the matting surfaces of the towing hitch.

The vehicle manufacturer's specifications regarding trailer load and max. vertical cup load are decisive for driving, and values for the towing hitch cannot be exceeded.

D-value formula:

$$\frac{\text{Max trailer weight [kg]} \times \text{Max vehicle weight [kg]}}{\text{Max trailer weight [kg]} + \text{Max vehicle weight [kg]}} \times \frac{9,81}{1000} = D \text{ [kN]}$$